

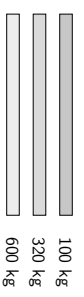

Description	Working area (theoretical)		Scale
	RUTHMANNSTIEGER® T 295 A		
	Kenworth T800		Com. No.
	Ruthmann GmbH & Co. KG		32780
	Ruthmannstr. 4		Sheet
	48712 Gescher		1
	Germany		No. Sheets
	 RUTHMANN <small>professionals at work</small>		2
Date: 15th January 2021	Format: A3	FTAthem	

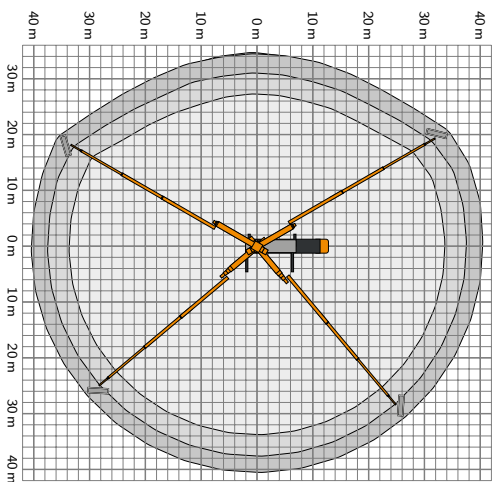
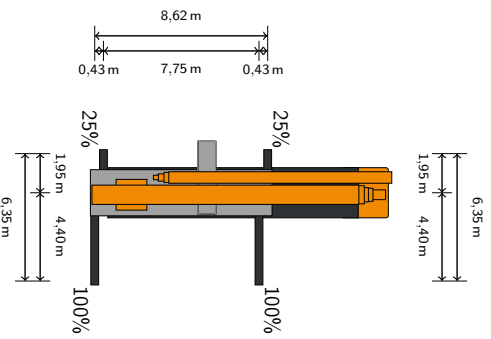
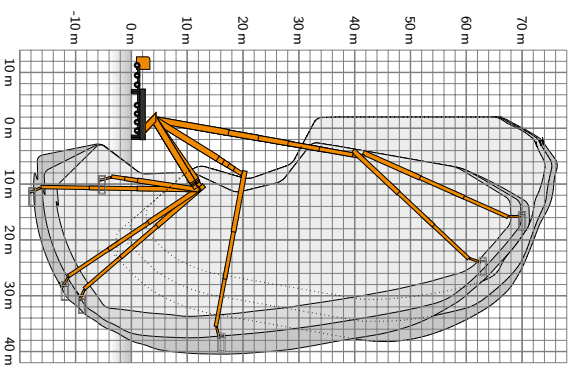
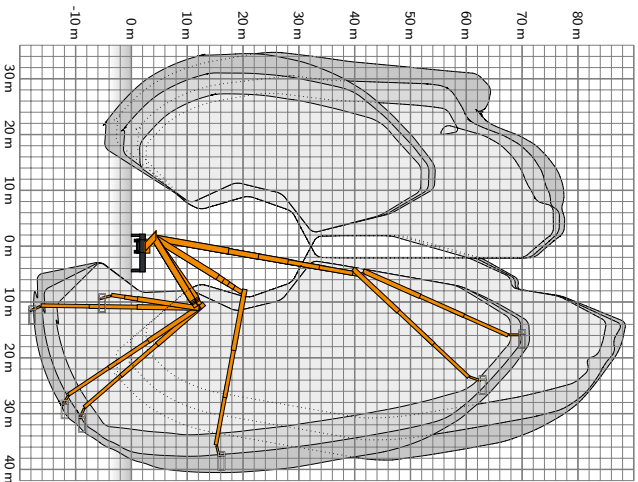
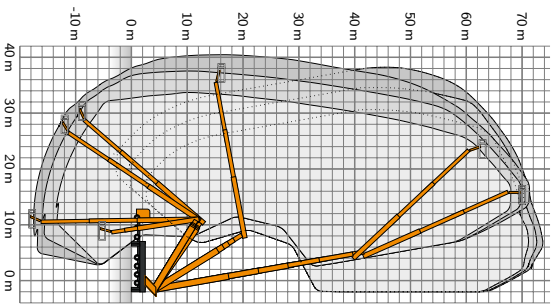

Description	Working area (theoretical)		Scale
	RUTHMANNSTIEGER® T 295 A		1:900
	Kenworth T800		Com. No.
			32780
	Ruthmann GmbH & Co. KG		Sheet
	Ruthmannstr. 4		2
	48712 Gescher		No. Sheets
	Germany		2
	 RUTHMANN <small>professionals at work</small>		
Date: 15th January 2021	Format: A3		FTAheim